

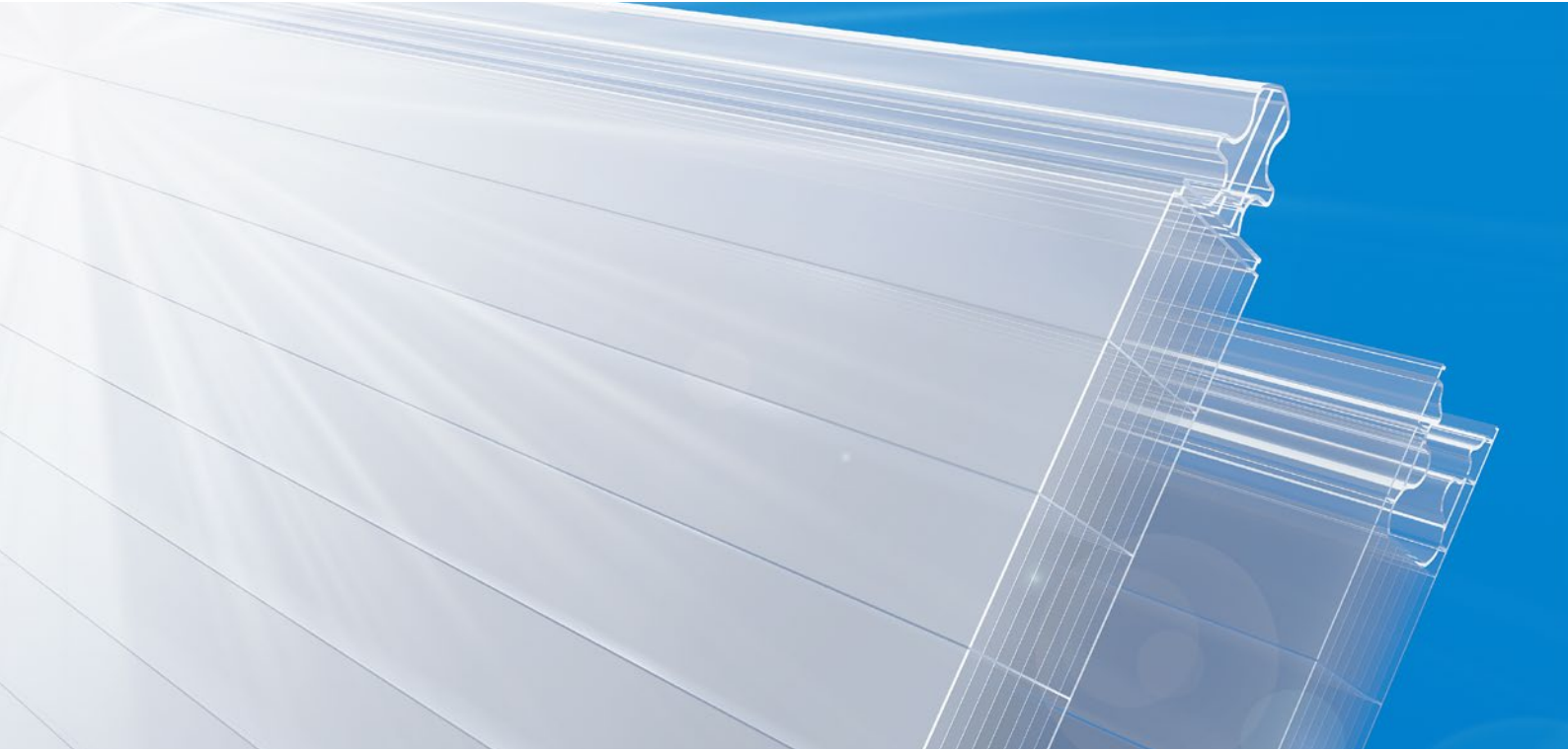

ALMAMARY
Aluminium & Skylight Factory

exolon
GROUP



Exolon® Click Panel Solutions

The high-tech polycarbonate panel

exolon[®]
Panel



Picture Source: SEP

Exolon® Group

Passionate about plastic sheets –

Exolon Group is a leading supplier of solid and multiwall sheets for various innovative applications. The company develops, produces and distributes polycarbonate sheets, polyester sheets and opaque sheet material made of high-quality plastic. Going beyond the obvious is our daily business, whether it is about the development of our products or the personal service we provide to our customers, to realize their needs. We are an inspiring partner with a human touch, that is putting our clients in the lead by listening, understanding, providing solutions and better experiences. We show what is and what is possible. And we make it happen.

New name with 40 years of experience

Even though the name is still young, Exolon Group has over 40 years of combined expertise in the extrusion of thermoplastic sheets. Exolon Group combines proven tradition with forward-looking innovations. Since 2020, the company has been part of the Serafin Group based in Munich.

Strong, clear, flexible.

The diverse European market demands flexibility and innovative spirit. In order to maintain its leading role, Exolon Group is therefore constantly driving new developments and conquering new business areas – close to the market and close to the customer. We are strong and confident about our skills, expertise and experience. Clear and straightforward in the way we behave and speak and flexible in our mindset. Including the selection and compilation of suitable raw materials, the ongoing optimization of production processes, the continuous training of employees and the promotion of innovative technologies.

Exolon® Panel features

High-tech material for creative ideas

The Exolon® Panel stands for a versatile range of top-class modular multiwall panel with a tongue and groove joint, designed to fulfil diverse and demanding requirements.

Polycarbonate panels open a world of architectural possibilities. Creative construction projects, such as translucent facades, curtain and partition walls, daylight systems, ceilings are all made possible with Exolon® Panel.

Exolon® sheets are renowned for good transparency, extremely high break resistance and impact strength, high dimensional behaviour stability and good electric insulation. They also obtain excellent fire ratings (see the specific datasheets for more detailed information). Thanks to the excellent extrusion expertise of the Exolon Group, our comprehensive quality management system and our advanced production processes, the consistency of our sheets is certified in accordance with DIN ISO 9001/2.

Light transmission

Ensuring the correct supply of sunlight into buildings significantly increases their sustainability. This is because sunlight reduces the electricity consumption of lighting, which consequently reduces its impact on the environment. Additionally, sunlight improves perceived well-being in a room, and in workplaces it increases productivity and safety. Exolon® Panels are the perfect devices for protecting rooms while ensuring the correct light intake.

Energy saving sheets for a better thermal insulation

Multiwall Panel offer much better heat insulation than single glazing, because of their special structure and low heat conductivity. This is measured as the U-value and depends on the number of chambers and the thickness of the air cushion: the more chambers and the thicker the air cushion, the lower the U-value. In recent years, Exolon Group has continued to develop sheets with improved thermal insulation. This helps reduce the CO₂ output associated with global warming.

Certified Fire Classification

Exolon® Panels comply with the strict EU standards in the area of fire classification according to EN 13501-1. In realistic large fire testing, our products were classified as a flame-retardant building material. The use of Exolon® Panel reduces the thermal load on buildings and the required fire resistance of building components. Suitable fire protection methods must be accounted for when considering the total fire protection concept for each building.

High mechanical performance

Exolon® Panels have excellent mechanical performance, and ensure compliance with safety and regulatory requirements. Furthermore, improved mechanical performance enables the design of the structures to be optimised, resulting in lower costs.

Easy to handle click-panel

Exolon® Panels are easy to handle and assemble. Their special tongue-and-groove coupling system is designed for maximum water tightness and easy set-up.



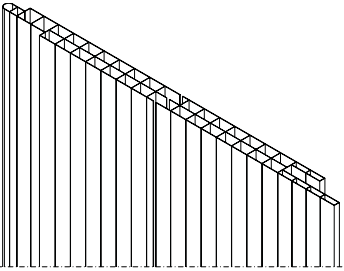
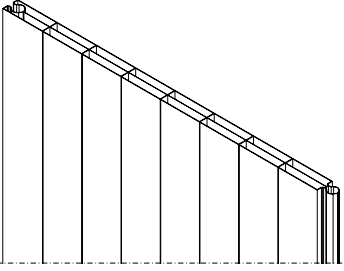
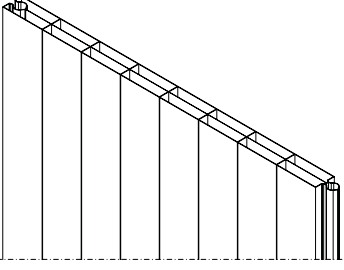
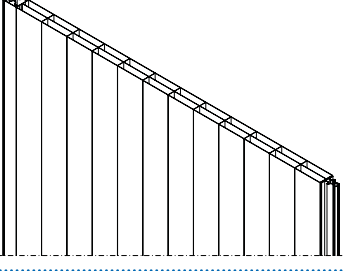
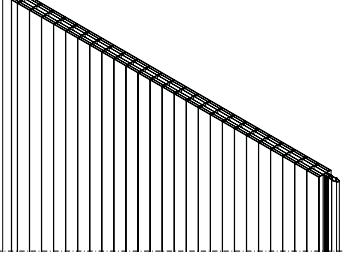

Exolon® PANEL Product Overview

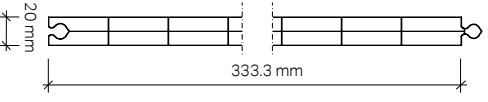
PRODUCT	BENEFITS	APPLICATIONS
<p>Exolon® PANEL 10</p> 	<ul style="list-style-type: none"> • Easy to install; • Light; • Joint designed for planar applications without the use of accessories. 	<ul style="list-style-type: none"> • False ceilings • Canopies • Mini-sheds • Small roofs
<p>Exolon® PANEL 16</p> 	<ul style="list-style-type: none"> • Easy to install; • Versatile for DIY; • Versatile dimensions; 	<ul style="list-style-type: none"> • False ceilings • Canopies • Mini-sheds • DIY
<p>Exolon® PANEL 20 LIGHT</p> 	<ul style="list-style-type: none"> • Easy to install; • Versatile for DIY; • Versatile dimensions; 	<ul style="list-style-type: none"> • Curtains • Partition walls • Sheds • Strip windows • DIY
<p>Exolon® PANEL 20 PLUS</p> 	<ul style="list-style-type: none"> • Patented connection; • Improved water tightness; • Reduced risk of dirt penetration; 	<ul style="list-style-type: none"> • Curtains • Partition walls • Sheds • Strip windows • Facades
<p>Exolon® PANEL 20 PLUS 6P</p> 	<ul style="list-style-type: none"> • 20 mm with high thermal insulation; • High strength connection; • Easy to install; 	<ul style="list-style-type: none"> • Curtains • Partition walls • Sheds • Strip windows • Facades

DIMENSIONS	TECHNICAL DATA	LIGHT TRANSMISSION	THERMAL INSULATION	FIRE CLASSIFICATION
<p>Exolon® PANEL 10</p> 	<ul style="list-style-type: none"> • Geometry: 3 walls in tunnel structure; • Thickness: 10 mm; • Width: 750 mm; • Length: On request; • Min. bending radius: 2,000 mm 	Clear: 79 %	Ug: 2.6 W/m²K	B-s1,d0
<p>Exolon® PANEL 16</p> 	<ul style="list-style-type: none"> • Geometry: 3 walls in tunnel structure; • Thickness: 16 mm; • Width: 333.3 mm; • Length: On request; • Min. bending radius: 3,200 mm 	Clear: 77 %	Ug: 2.3 W/m²K	B-s1,d0
<p>Exolon® PANEL 20 LIGHT</p> 	<ul style="list-style-type: none"> • Geometry: 3 walls in tunnel structure; • Thickness: 20 mm; • Width: 333,3 mm; • Length: On request; • Min. bending radius: 4,000 mm 	Clear: 76 %	Ug: 2.1 W/m²K	B-s1,d0
<p>Exolon® PANEL 20 PLUS</p> 	<ul style="list-style-type: none"> • Geometry: 3 walls in tunnel structure; • Thickness: 20 mm; • Width: 500 mm; • Length: On request; • Min. bending radius: 4,000 mm 	Clear: 76 %	Ug: 2.1 W/m²K	B-s1,d0
<p>Exolon® PANEL 20 PLUS 6P</p> 	<ul style="list-style-type: none"> • Geometry: 6 walls in tunnel structure; • Thickness: 20 mm; • Width: 500 mm; • Length: On request; • Min. bending radius: 4,000 mm 	Clear: 64 %	Ug: 1.7 W/m²K	B-s1,d0

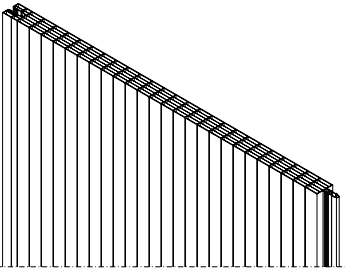
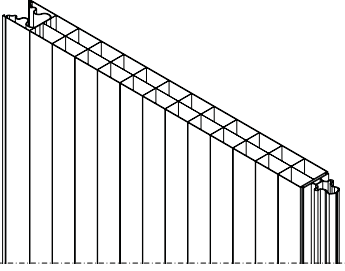
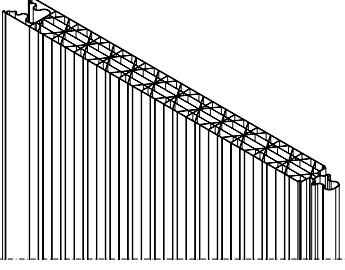
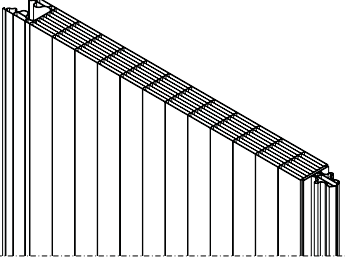
Exolon® PANEL Product Overview

PRODUCT	BENEFITS	APPLICATIONS
<p>Exolon® PANEL 25 PLUS 6P</p> 	<ul style="list-style-type: none"> • 25 mm with high thermal insulation; • High strength connection; • Easy to install; 	<ul style="list-style-type: none"> • Curtains • Partition walls • Sheds • Strip windows Facades
<p>Exolon® PANEL 40 3P</p> 	<ul style="list-style-type: none"> • Patented connection; • Improved water tightness; • Reduced risk of dirt penetration; • 40 mm with high light transmission; 	<ul style="list-style-type: none"> • Facades • Sheds • Strip windows • Daylight systems • Partition walls
<p>Exolon® PANEL 40 5PX</p> 	<ul style="list-style-type: none"> • Patented connection; • Improved water tightness; • Reduced risk of dirt penetration; • X structure to improve stiffness; 	<ul style="list-style-type: none"> • Facades • Sheds • Strip windows • Daylight systems • Partition walls
<p>Exolon® PANEL 40 9P</p> 	<ul style="list-style-type: none"> • Patented connection; • Improved water tightness; • Reduced risk of dirt penetration; • High thermal insulation; 	<ul style="list-style-type: none"> • Facades • Sheds • Strip windows • Daylight systems • Partition walls

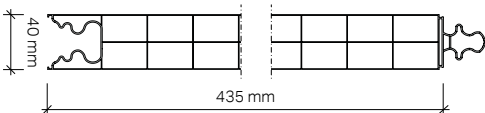
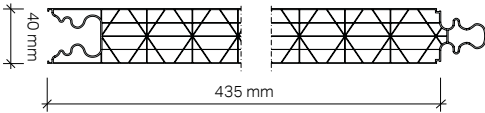
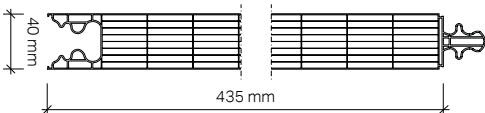
DIMENSIONS	TECHNICAL DATA	LIGHT TRANSMISSION	THERMAL INSULATION	FIRE CLASSIFICATION
<p>Exolon® PANEL 25 PLUS 6P</p> 	<ul style="list-style-type: none"> • Geometry: 6 walls in tunnel structure; • Thickness: 25 mm; • Width: 500 mm; • Length: On request; • Min. bending radius: 5,000 mm 	<p>Clear: 62 %</p>	<p>Ug: 1.5 W/m²K</p>	<p>B-s1,d0</p>
<p>Exolon® PANEL 40 3P</p> 	<ul style="list-style-type: none"> • Geometry: 3 walls in tunnel structure; • Thickness: 40 mm; • Width: 435 mm; • Length: On request; • Min. bending radius: 8,000 mm 	<p>Clear: 76 %</p>	<p>Ug: 1.7 W/m²K</p>	<p>B-s1,d0</p>
<p>Exolon® PANEL 40 5PX</p> 	<ul style="list-style-type: none"> • Geometry: 7 walls in X structure; • Thickness: 40 mm; • Width: 435 mm; • Length: On request; • Min. bending radius: 8,000 mm 	<p>Clear: 54 %</p>	<p>Ug: 1.2 W/m²K</p>	<p>B-s1,d0</p>
<p>Exolon® PANEL 40 9P</p> 	<ul style="list-style-type: none"> • Geometry: 9 walls in tunnel structure; • Thickness: 40 mm; • Width: 435 mm; • Length: On request; • Min. bending radius: 8,000 mm 	<p>Clear: 48 %</p>	<p>Ug: 1.0 W/m²K</p>	<p>B-s1,d0</p>

Exolon® PANEL 10

The click panel made of polycarbonate has a coextruded UV protection on one side and a 10-years-warranty. The panel is easy to install and mainly used for ceilings.

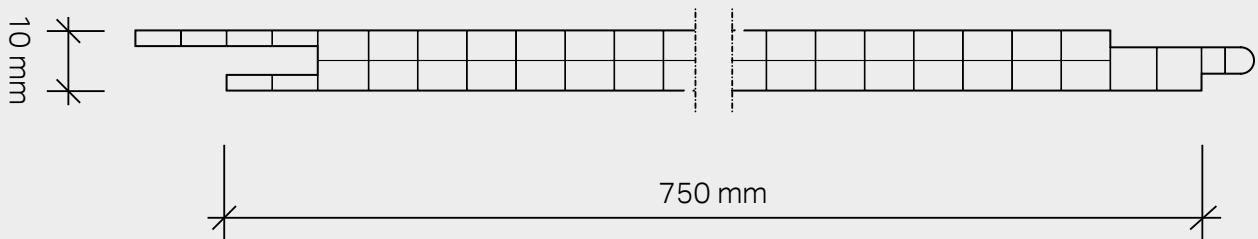

BENEFITS

- ✓ The panel has a 3-wall structure that maximises light transmission.
- ✓ Lightweight and easy to install.
- ✓ Simple interlocking that doesn't need any joining element



AREAS OF APPLICATION

Exolon® PANEL 10 is easy to use on ceilings, and small sheds and roofs.

SPECIFICATION ITEM

Suspended ceiling/canopy made of 10-mm thick UV non-protected multiwall polycarbonate modular panels over entire 750 mm wide section. Thermal transmittance coefficient $U_g = 2.6 \text{ W/m}^2\text{K}$, fire classification B-s1,d0.



TECHNICAL DATA

Geometry	3 walls with tunnel structure
Thickness	10 mm
Width	750 mm
Length	Custom
Light transmission	Clear: 79 %
Heat transfer coefficient (U_g)	2.6 $\text{W/m}^2\text{K}$
Fire Classification	B-s1,d0
Minimum bending radius	2,000 mm
Thermal linear expansion	0.065 mm/m °C
Service Temperature	-100 / +120°C without load
Available colours	Clear, Opal, Bronze, Other colours on request
Additional services	UV protection, Thermowelding, Taping



MECHANICAL PERFORMANCES

VERTICAL RESISTANCE

"H"	kg/m ²	with max. light 1/50 indicator
100/150 cm	50	With fixed panels

Exolon® PANEL 16

The click panel made of polycarbonate comes along with a coextruded UV protection on one side and a 10-years-warranty. That makes it perfect for outdoor installations. The panel is easy to install and mainly used for vertical applications e.g. internal and dividing walls.

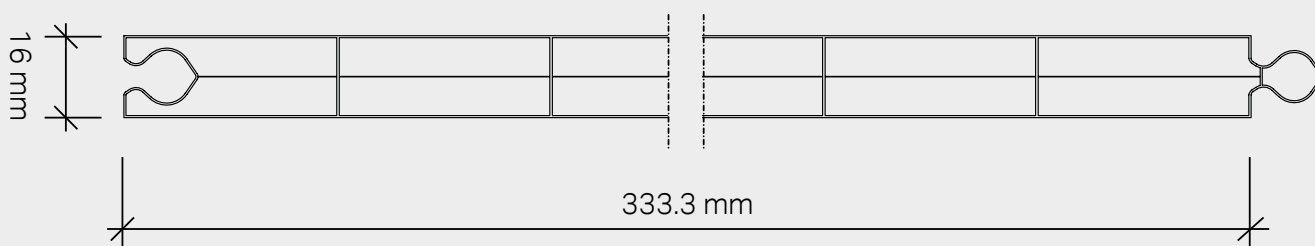

BENEFITS

- ✓ The panel has a 3-wall structure that maximises light transmission.
- ✓ The 333.3 mm width is designed to facilitate easy setting up.
- ✓ Special steel hooks are included that make the panel easy to mount.

AREAS OF APPLICATION

Exolon® PANEL 16 is easy to use on infills, sheds, skylights, strip windows, coverings, dividing walls and internal or external installations.

SPECIFICATION ITEM

Supply of modular panels for walls or windows; 333.3 mm coextruded alveolar polycarbonate, with external UV protection. 16 mm thick, flush-mounted and double chambered, with tongue-and-groove insertion. Technical data: transmittance $U_g = 2.3 \text{ W/m}^2\text{K}$, fire classification B-s1,d0, transparent opal or coloured finish.

TECHNICAL DATA

Geometry	3 walls in tunnel structure
Thickness	16 mm
Width	333.3 mm
Length	Custom
Light transmission	Clear: 77 %
Global heat transfer coefficient (U_g)	2.3 $\text{W/m}^2\text{K}$
Fire Classification	B-s1,d0
Minimum bending radius	3,200 mm
Thermal linear expansion	0.065 mm/m °C
Service Temperature	-100 / +120 °C without load
Available colours	Clear, Opal, Bronze, Other colours on request
Additional services	Taping

MECHANICAL PERFORMANCES

VERTICAL RESISTANCE

"H"	kg/m ²	with max. light 1/50 indicator
170 cm	60	Free light
180/300 cm	80	width 100 cm step structure

Exolon® PANEL 20 Light

The 20 Light click panel made of polycarbonate comes along with a coextruded UV protection on one side and a 10-years-warranty and is used for outdoor installations. The panel is easy to install and mainly used for vertical applications e.g. internal and dividing walls.

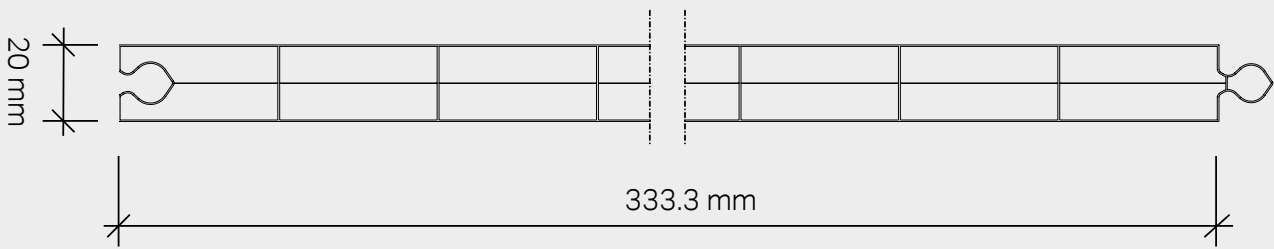

BENEFITS

- ✓ The panel has a 3-wall structure that maximises light transmission.
- ✓ The 333.3 mm width is designed to facilitate easy set-up.
- ✓ Special steel hooks are included that make the panel easy to mount.

AREAS OF APPLICATION

Exolon® PANEL 20 Light is easy to use on infills, sheds, skylights, strip windows, coverings, dividing walls and internal or external installations.

SPECIFICATION ITEM

Supply of modular panels for walls or windows; 333.3 mm coextruded alveolar polycarbonate, with external UV protection. 20 mm thick, flush-mounted and double chambered, with tongue-and-groove insertion. Technical data: transmittance $U_g = 2.1 \text{ W/m}^2\text{K}$, fire classification B-s1,d0, transparent opal or coloured finish.

TECHNICAL DATA

Geometry	3 walls with tunnel structure
Thickness	20 mm
Width	333.3 mm
Length	Custom
Light transmission	Clear: 76 %
Heat transfer coefficient (U_g)	$2.1 \text{ W/m}^2\text{K}$
Fire Classification	B-s1,d0
Minimum bending radius	4,000 mm
Thermal linear expansion	$0.065 \text{ mm/m } ^\circ\text{C}$
Service Temperature	$-100 / +120 \text{ } ^\circ\text{C}$ without load
Available colours	Clear, Opal, Bronze, Other colours on request
Additional services	Taping

MECHANICAL PERFORMANCES

VERTICAL RESISTANCE

"H"	kg/m ²	with max. light 1/50 indicator
180 cm	60	Free light
180/300 cm	80	width 100 cm step structure

Exolon® PANEL 20 Plus

Versatility and performance for every situation – The 20 Plus click panel made of polycarbonate comes along with a coextruded UV protection on one side and a 10-years-warranty. That makes it perfect for outdoor installations. The panel is easy to install and mainly used for vertical applications e.g. facades. It is designed to maximize light transmission, making it ideal for all those projects where daylight is a must.

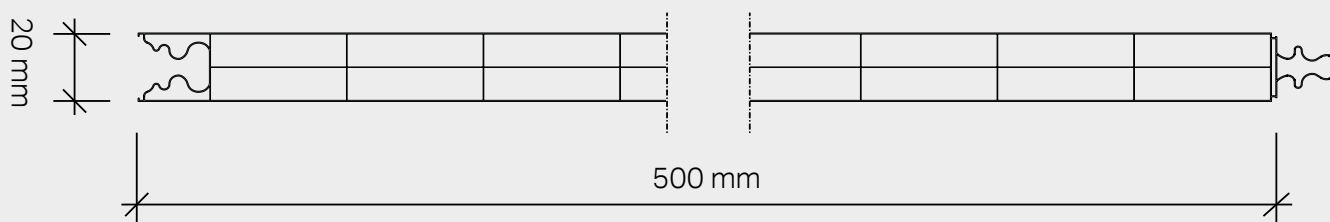

BENEFITS

- ✓ The patented tongue-and-groove design ensures total watertightness, without the need to use a sealant.
- ✓ The panel has a 3-wall structure that maximises light transmission.
- ✓ Special steel hooks are included that make the panel easy to mount.



AREAS OF APPLICATION

Exolon® PANEL 20 Plus is easy to use on facades, infills, sheds, skylights, strip windows, coverings, dividing walls and internal or external installations.

SPECIFICATION ITEM

Supply of modular panels for walls or windows; 500 mm coextruded alveolar polycarbonate, with external UV protection. 20 mm thick, flush-mounted and double-chambered, with patented tongue-and-groove coupling and watertight seal. Technical data: transmittance $U_g = 2.1 \text{ W/m}^2\text{K}$, fire classification B-s1,d0, transparent opal or coloured finish.



TECHNICAL DATA

Geometry	3 walls with tunnel structure
Thickness	20 mm
Width	500 mm
Length	Custom
Light transmission	Clear: 76 %
Heat transfer coefficient (U_g)	2.1 $\text{W/m}^2\text{K}$
Fire Classification	B-s1,d0
Minimum bending radius	4,000 mm
Thermal linear expansion	0.065 mm/m °C
Service Temperature	-100 / +120 °C without load
Available colours	Clear, Opal, Bronze, Other colours on demand
Additional services	Taping



MECHANICAL PERFORMANCES

FREE LIGHT VERTICAL RESISTANCE

max. height	pressure resistance
1,400 mm	50 kg/m^2

VERTICAL TRAVERSE RESISTANCE

beam pitch every	pressure resistance
1,500 mm	70 kg/m^2
1,300 mm	125 kg/m^2 *

* Load certified by Jordan Institute – 1/50 indicator

Exolon® PANEL 20 Plus 6P

To optimize energy consumptions – The 20 Plus 6P click panel made of polycarbonate has a coextruded UV protection on one side and a 10-years-warranty. That makes it perfect for outdoor installations. The panel is easy to install and mainly used for vertical applications e.g. facades. The 6-wall structure allows high thermal insulation for a 20 mm sheet, reducing the energy consumptions and the environmental impact.

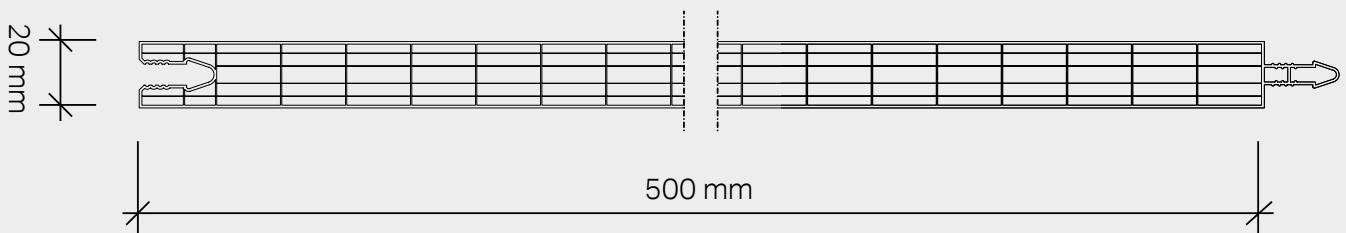

BENEFITS

- ✓ The tongue-and-groove design ensures total watertightness, without the need to use a sealant.
- ✓ The panel has a 6-wall structure to maximise thermal insulation and energy savings, with a thickness of 20 mm.
- ✓ Special steel hooks are included that make the panel easy to mount.

AREAS OF APPLICATION

Exolon® PANEL 20 Plus 6P is easy to use on facades, infills, sheds, skylights, strip windows, coverings, dividing walls and internal or external installations.

SPECIFICATION ITEM

Supply of modular panels for walls or windows; 500 mm coextruded alveolar polycarbonate, with external UV protection. 20 mm thick 6-wall, coplanar panel with watertight tongue-and-groove coupling. Technical data: transmittance $U_g = 1.7 \text{ W/m}^2\text{K}$, fire classification B-s1,d0, transparent frost, opal or coloured finish.

TECHNICAL DATA

Geometry	6 walls with tunnel structure
Thickness	20 mm
Width	500 mm
Length	Custom
Light transmission	Clear: 64 %
Heat transfer coefficient (U_g)	1.7 $\text{W/m}^2\text{K}$
Fire Classification	B-s1,d0
Minimum bending radius	4,000 mm
Thermal linear expansion	0.065 mm/m °C
Service Temperature	-100 / +120 °C without load
Available colours	Clear frost, Opal, Bronze, Other colours on request
Additional services	Taping

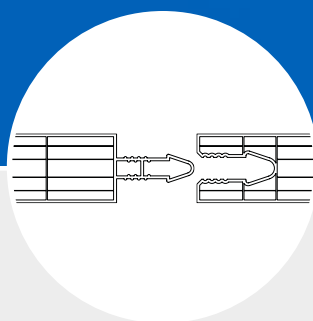
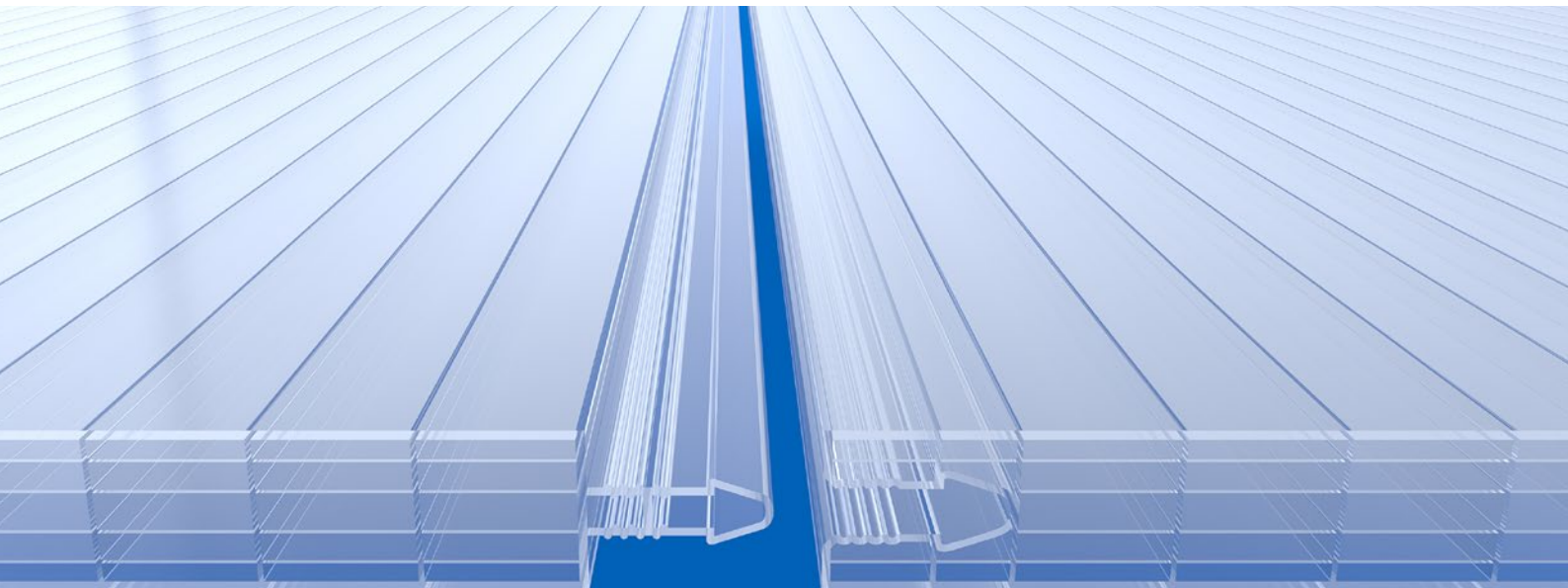

MECHANICAL PERFORMANCES

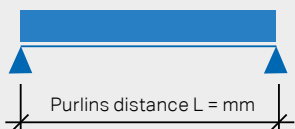
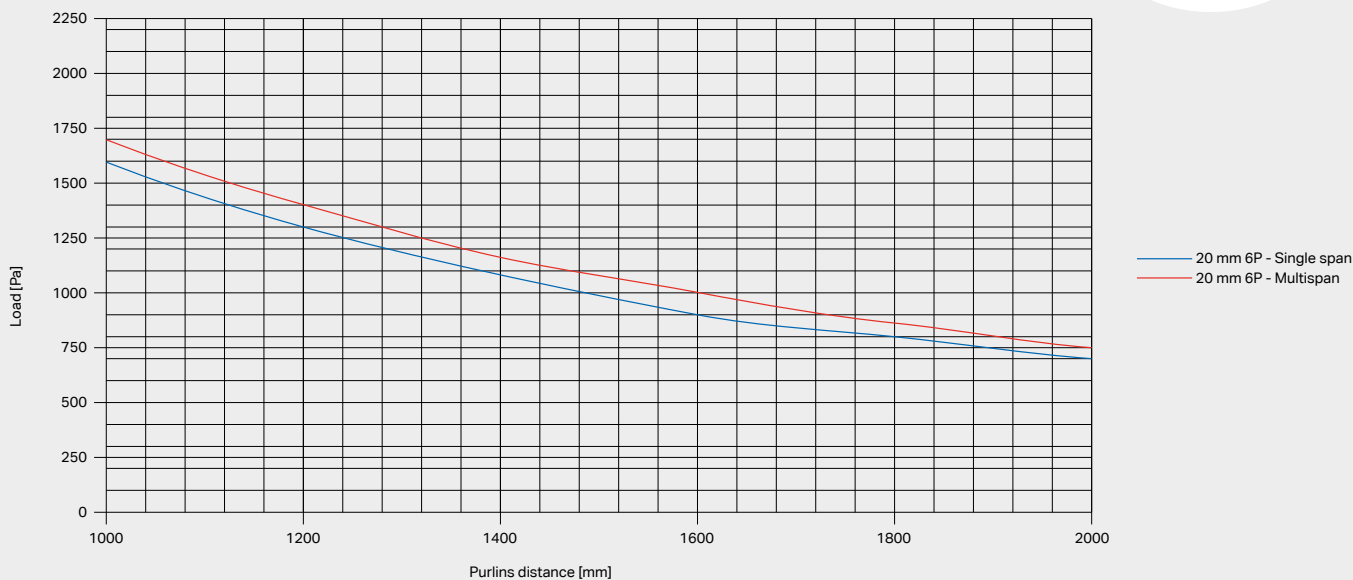

Single span system is generally used for windows and sheds or in the applications where the panels are supported on the edges only.

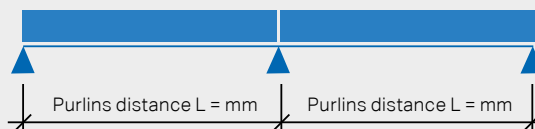

Multi span system is generally used for facades or in the applications where the panels are supported on the edges and along the length with intermediate purlins.

Exolon® PANEL 25 Plus 6P

To optimize energy consumptions – The 25 Plus 6P click panel made of polycarbonate comes along with a coextruded UV protection on one side and a 10-years-warranty. That makes it perfect for outdoor installations. The panel is easy to install and mainly used for vertical applications e.g. facades. The 6-wall structure allows high thermal insulation for a 25 mm sheet, reducing the energy consumptions and the environmental impact.

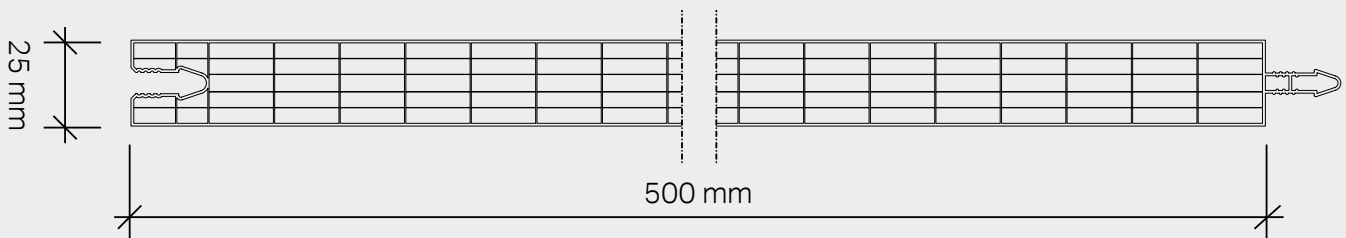

BENEFITS

- ✓ The tongue-and-groove design ensures total watertightness, without the need to use a sealant.
- ✓ The panel has a 6-wall structure to maximise thermal insulation and energy savings, with a thickness of 25 mm.
- ✓ Special steel hooks are included that make the panel easy to mount.

AREAS OF APPLICATION

Exolon® PANEL 25 Plus 6P is easy to use on facades, infills, sheds, skylights, strip windows, coverings, dividing walls and internal or external installations.

TECHNICAL DATA

Geometry	6 walls with tunnel structure
Thickness	25 mm
Width	500 mm
Length	Custom
Light transmission	Clear: 62 %
Heat transfer coefficient (Ug)	1.5 W/m²K
Fire Classification	B-s1,d0
Minimum bending radius	5,000 mm
Thermal linear expansion	0.065 mm/m °C
Service Temperature	-100 / +120 °C without load
Available colours	Clear frost, Opal, Bronze, Other colours on request
Additional services	Taping

SPECIFICATION ITEM

Supply of modular panels for walls or windows; 500 mm coextruded alveolar polycarbonate, with external UV protection. 25 mm thick 6-wall, coplanar panel with watertight tongue-and-groove coupling. Technical data: transmittance Ug = 1.5 W/m²K. fire classification B-s1,d0, transparent frost, opal or coloured finish.

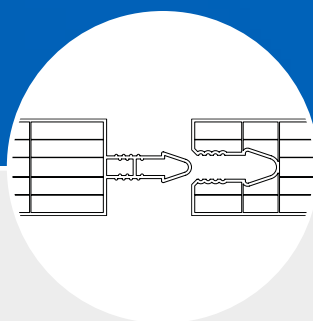
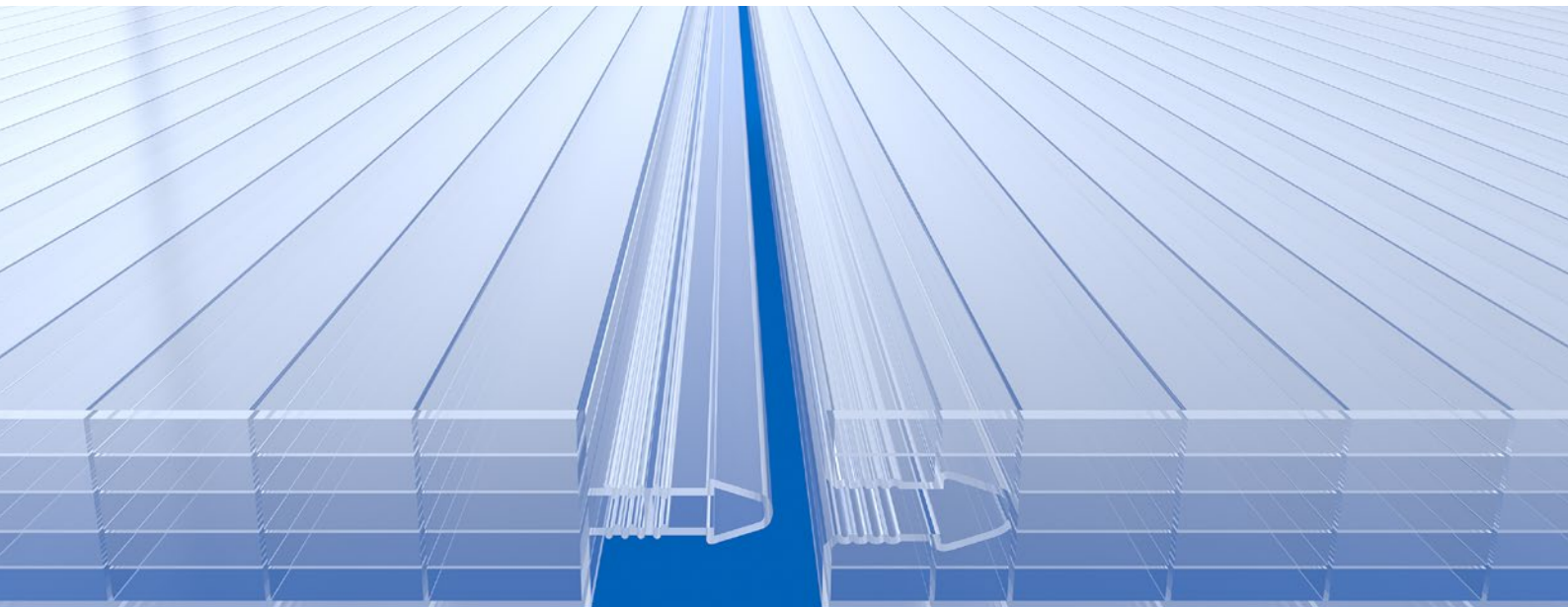

MECHANICAL PERFORMANCES

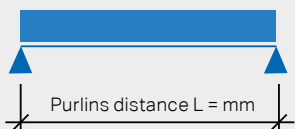
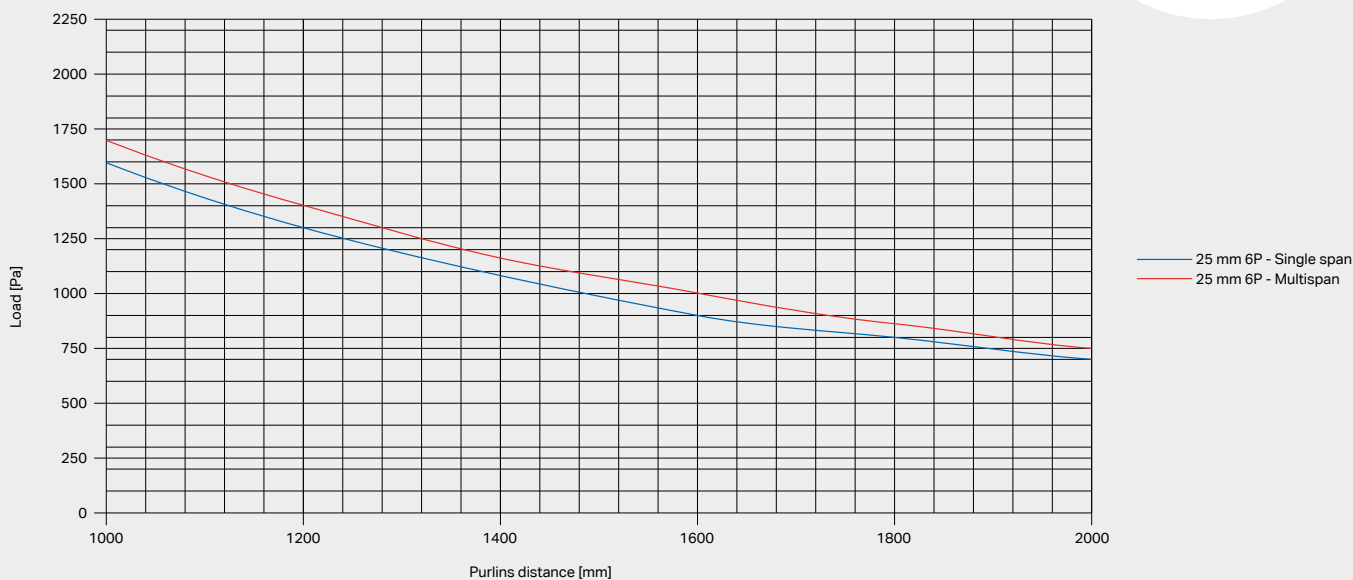

Single span system is generally used for windows and sheds or in the applications where the panels are supported on the edges only.

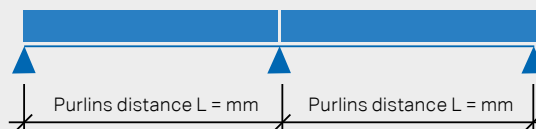

Multi span system is generally used for facades or in the applications where the panels are supported on the edges and along the length with intermediate purlins.

Accessories for Exolon® Panel Types 20/25 Plus

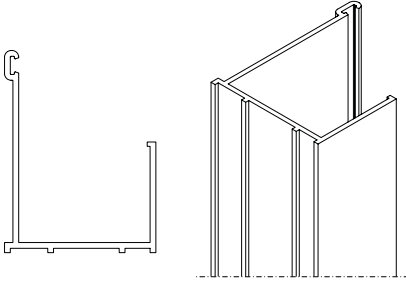
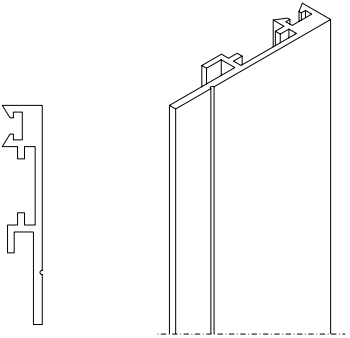
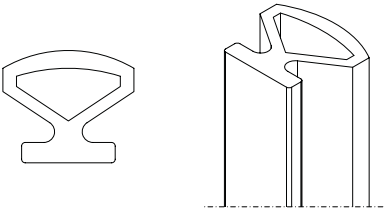
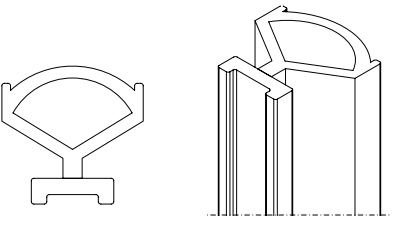
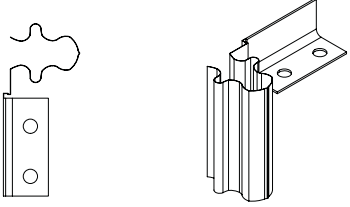
ACCESSORIES	CODE	DESCRIPTION	USE
	PAEF2025PL	<ul style="list-style-type: none"> Anodised aluminium L-profile (10 micron) 20 mm thickness 6,500 mm length 	Upper, lower and side profile
	PAEF12742A	<ul style="list-style-type: none"> Anodised aluminium panel fixing element 20/25 mm thickness 6,500 mm length 	Panel fixing element combined with PAEF2025PL
	GUAPA01	<ul style="list-style-type: none"> EPDM gasket 	PAEF2025PL profile gasket
	GUAPA03	<ul style="list-style-type: none"> EPDM gasket 	PAEF12742A panel fixing element gasket
	G00020 EXOLON PANEL 20 LIGHT G00020PLUS EXOLON PANEL 20 PLUS G0002025PLUS EXOLON PANEL 20/25 PLUS 6P	<ul style="list-style-type: none"> Steel hook 	Steel hook for panel mounting

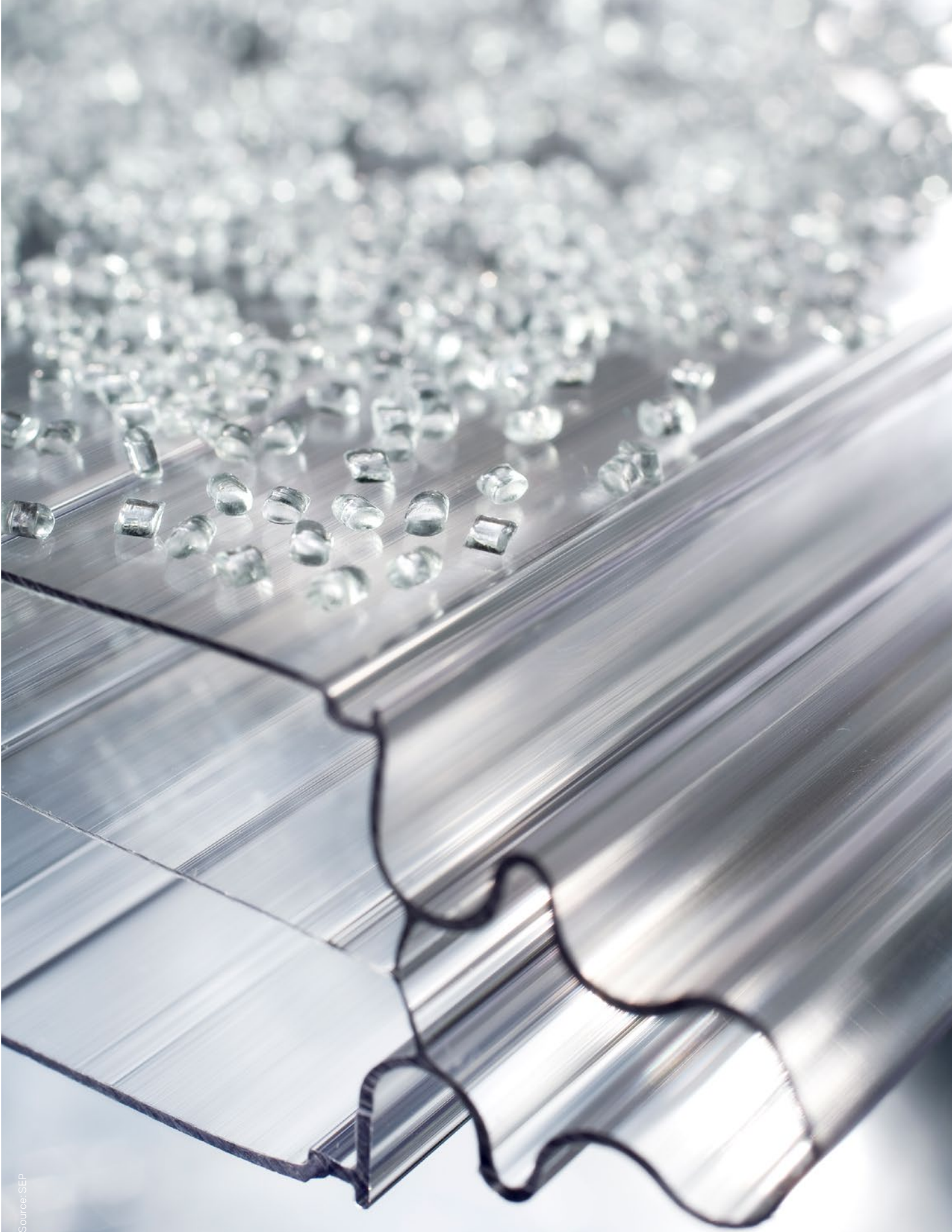

Exolon® PANEL 40 3P

To maximize light transmission – The 3P click panel made of polycarbonate has a coextruded UV protection on one side and a 10-years-warranty. That makes it perfect for outdoor installations. The panel is easy to install and mainly used for vertical applications e.g. facades. It is designed to maximize light transmission, making it ideal for all those projects where daylight is a must.

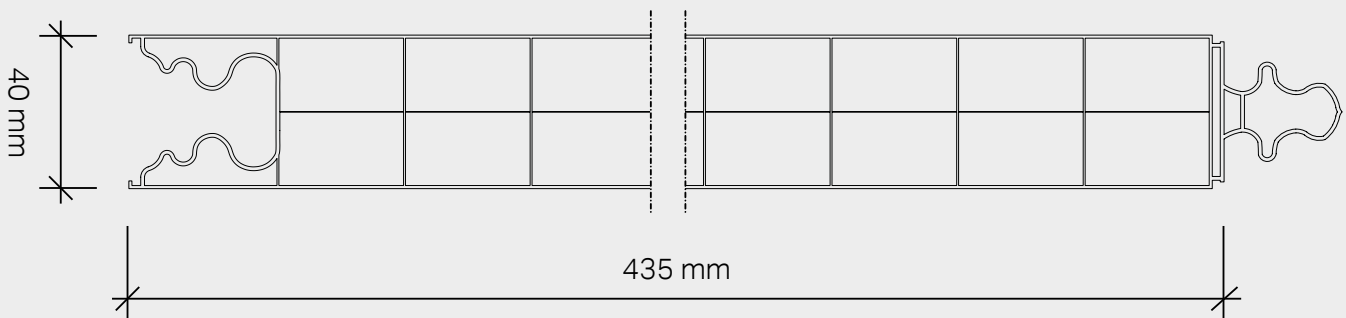

BENEFITS

- ✓ The patented tongue and groove coupling ensures total watertightness, without the need to use a sealant.
- ✓ The panel has a 3-wall structure that maximises light transmission and optimises weight.
- ✓ Special steel hooks are included that make the panel easy to mount.

AREAS OF APPLICATION

Exolon® PANEL 40 3P is easy to use on facades, infills, sheds, skylights, strip windows, coverings, dividing walls and internal or external installations.

SPECIFICATION ITEM

Modular panel for coverings, walls or windows; 435 mm coextruded alveolar polycarbonate, external side with UV protection. 40 mm thick, flush-mounted and double-chambered, with patented coupling and watertight seal. Technical data: transmittance $U_g = 1.7 \text{ W/m}^2\text{K}$, fire classification B-s1,d0, transparent opal or coloured finish.

TECHNICAL DATA

Geometry	3 walls with tunnel structure
Thickness	40 mm
Width	435 mm
Length	Custom
Light transmission	Clear: 76 %
Heat transfer coefficient (U_g)	1.7 $\text{W/m}^2\text{K}$
Fire Classification	B-s1,d0
Minimum bending radius	8,000 mm
Sound reduction index	17 dB
Thermal linear expansion	0.065 mm/m °C
Service Temperature	-100 / +120 °C without load
Available colours	Clear, Opal, Bronze, Other colours on request
Additional services	Taping

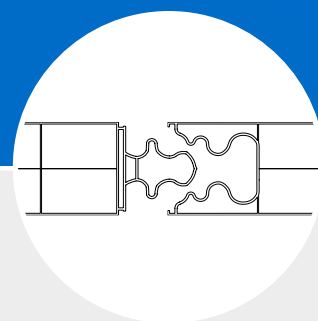
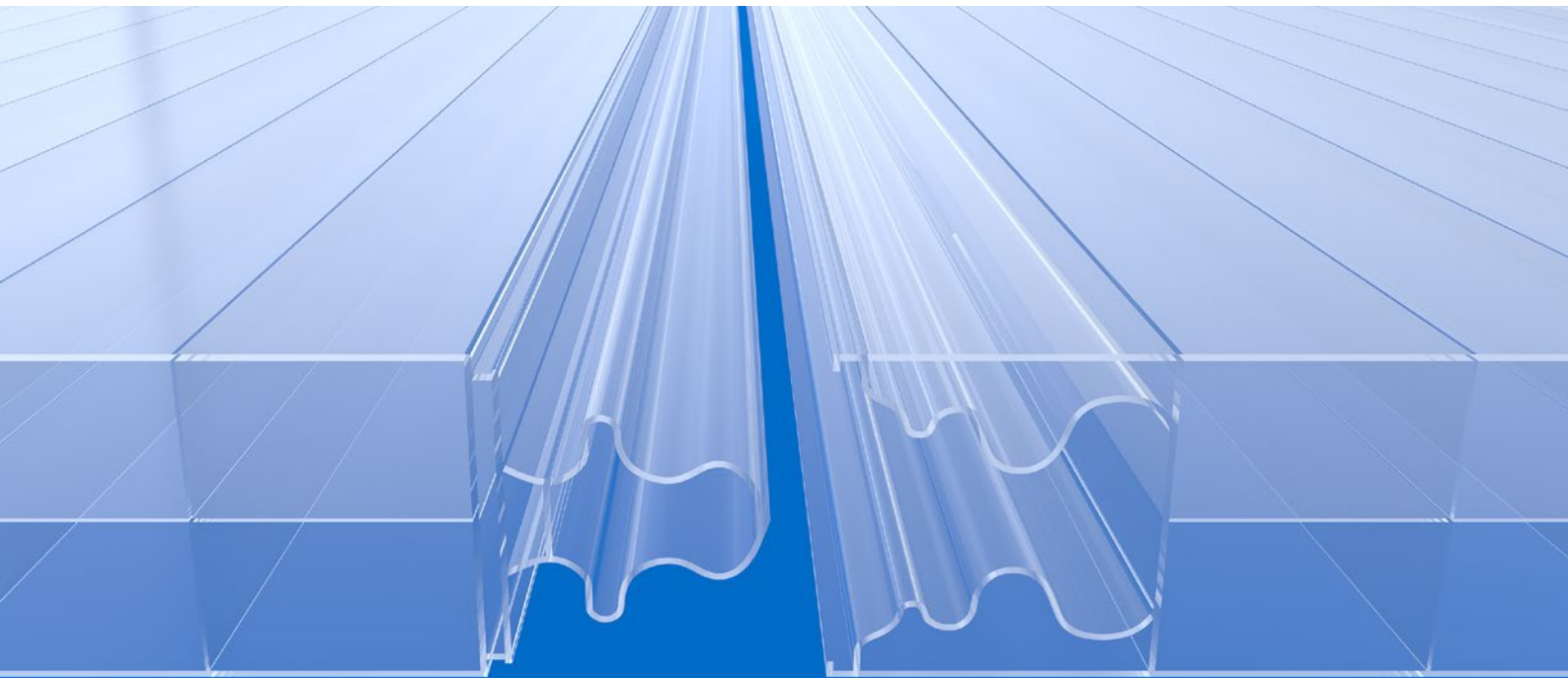

patented watertight coupling

MECHANICAL PERFORMANCES

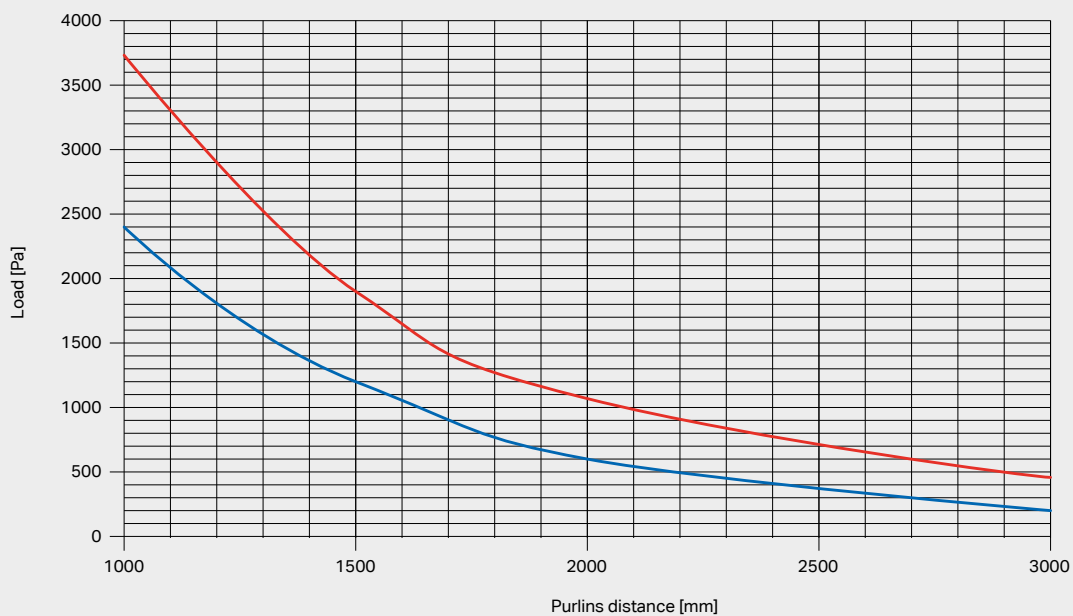

— 40 mm 3P - Single span
— 40 mm 3P - Multispan

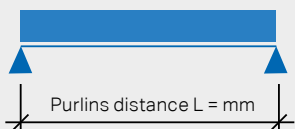

Single span system is generally used for windows and sheds or in the applications where the panels are supported on the edges only.

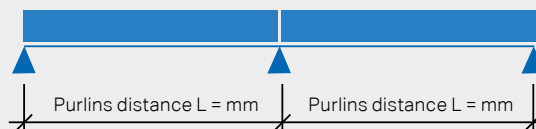

Multi span system is generally used for facades or in the applications where the panels are supported on the edges and along the length with intermediate purlins.

Exolon® PANEL 40 5PX

Versatility and performance for every situation – The 5PX click panel made of polycarbonate comes along with a coextruded UV protection on one side and a 10-years-warranty. That makes it perfect for outdoor installations. The panel is easy to install and mainly used for vertical applications e.g. facades. Its X structure increases the stiffness and optimizes mechanical performance, making it versatile to meet various architectural specifications.

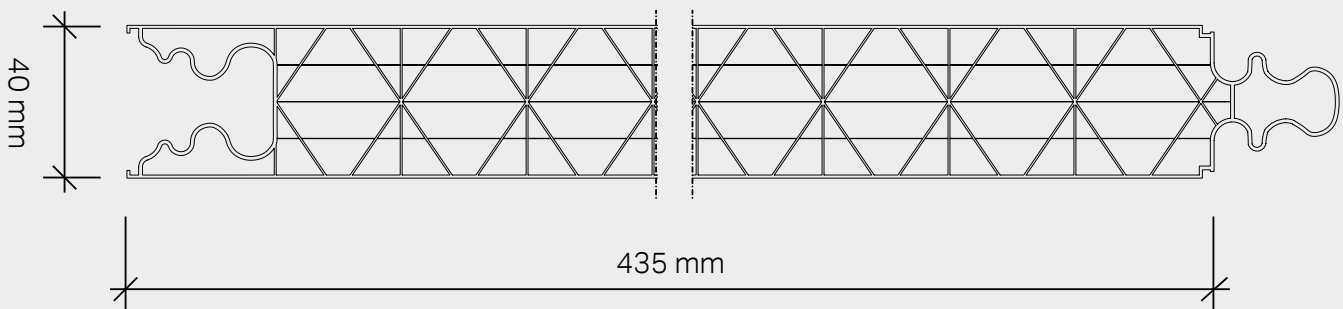

BENEFITS

- ✓ The patented tongue and groove design ensures total watertightness, without the need to use a sealant.
- ✓ The panel has an X-structure to increase rigidity and make it versatile for different application needs.
- ✓ Special steel hooks are included that make the panel easy to mount.



AREAS OF APPLICATION

Exolon® PANEL 40 5PX is easy to use on facades, infills, sheds, skylights, strip windows, coverings, dividing walls and internal or external installations.

SPECIFICATION ITEM

Modular panel for coverings, walls or windows; 435 mm coextruded alveolar polycarbonate, external side with UV protection. 40 mm thick, coplanar, with patented watertight joint. Technical features: Ug transmittance = 1.2 W/m²K, fire reaction B-s1,d0, transparent opal or coloured finishing.



TECHNICAL DATA

Geometry	7 walls with X structure
Thickness	40 mm
Width	435 mm
Length	Custom
Light transmission	Clear: 54 %
Heat transfer coefficient (Ug)	1.2 W/m ² K
Fire Classification	B-s1,d0
Minimum bending radius	8,000 mm
Sound reduction index	18 dB
Thermal linear expansion	0.065 mm/m °C
Service Temperature	-100 / +120 °C without load
Available colours	Clear, Opal, Bronze, Other colours on request
Additional services	Taping

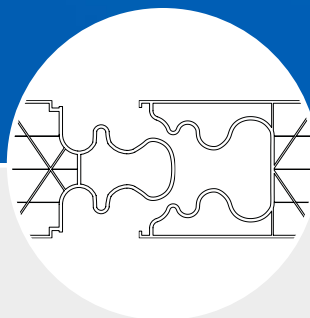
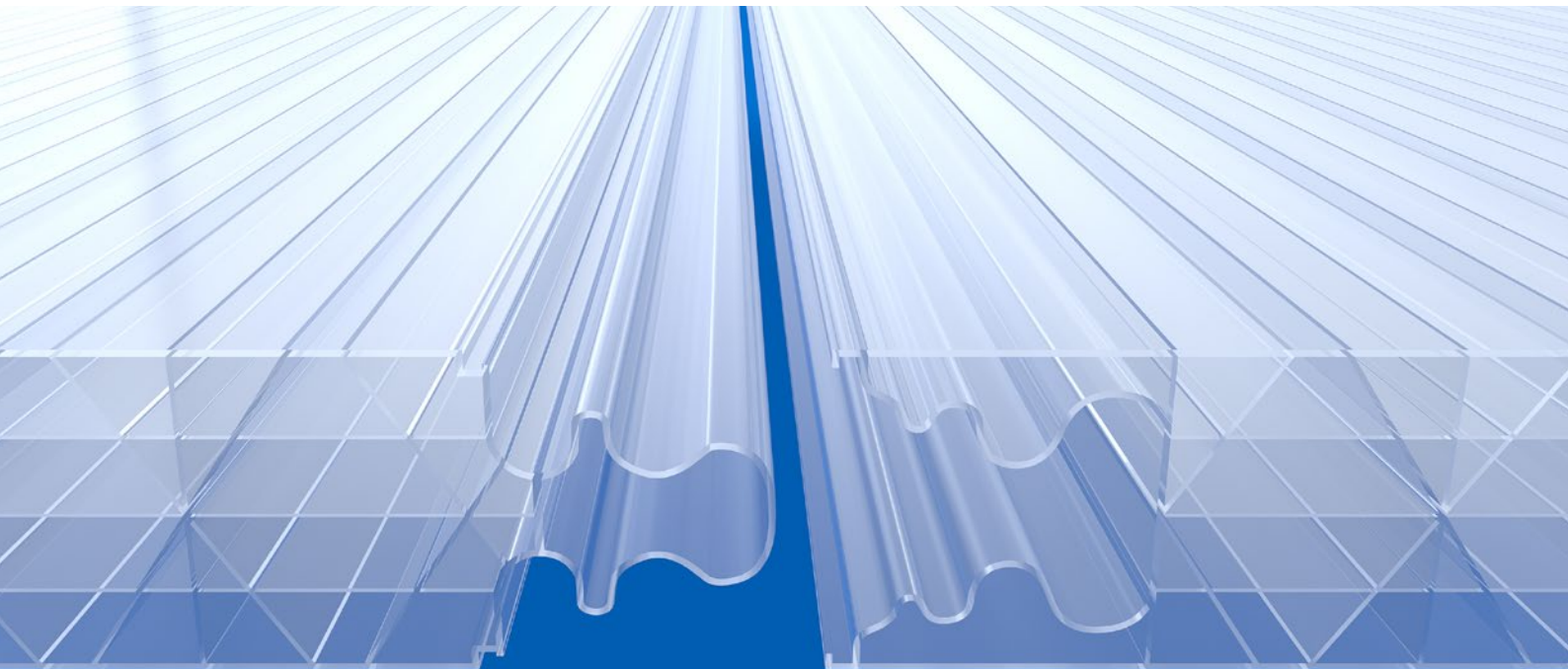

MECHANICAL PERFORMANCES

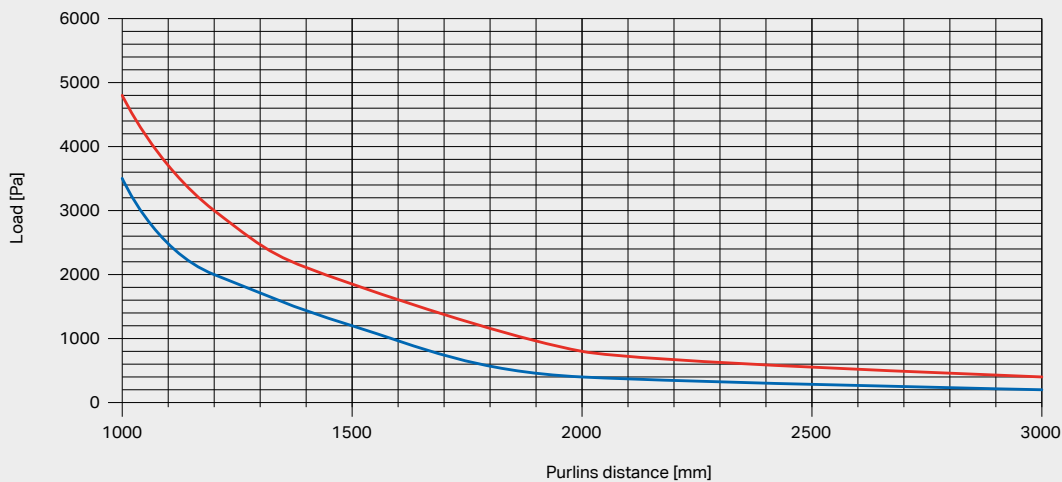

patented watertight coupling

— 40 mm 5PX - Single span
— 40 mm 5PX - Multispan

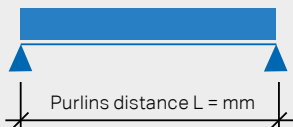

Single span system is generally used for windows and sheds or in the applications where the panels are supported on the edges only.

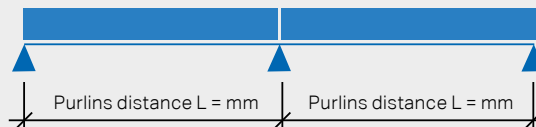

Multi span system is generally used for facades or in the applications where the panels are supported on the edges and along the length with intermediate purlins.

Exolon® PANEL 40 9P

To maximize energy savings – The 9-wall click panel made of polycarbonate comes along with a coextruded UV protection on one side and a 10-years-warranty. That makes it perfect for outdoor installations. The panel is easy to install and mainly used for vertical applications e.g. facades. Due to its low Ug Value it improves the thermal insulation and reduces the energy consumptions.

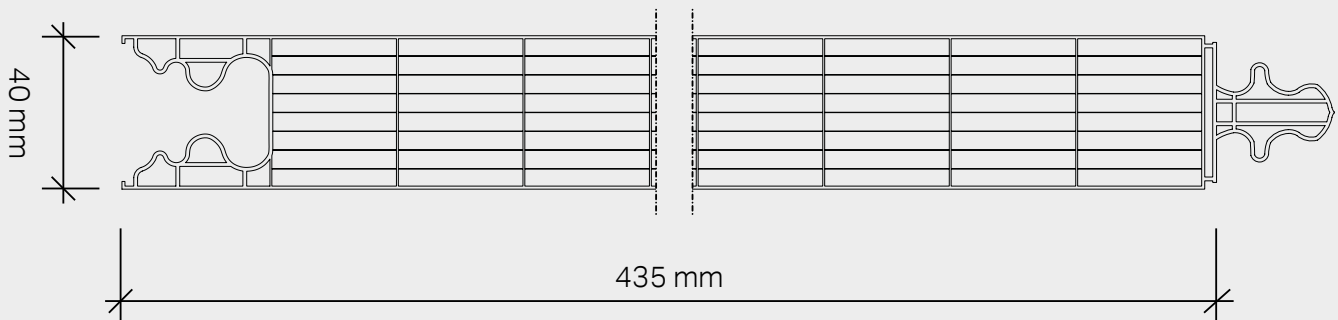

BENEFITS

- ✓ The patented tongue and groove design ensures full watertightness without the need to use a sealant.
- ✓ The panel has 9 walls, maximising thermal insulation and reducing energy consumption.
- ✓ Special steel hooks are included making the panel easy to mount.



AREAS OF APPLICATION

Exolon® PANEL 40 9P is easy to use on facades, infills, sheds, skylights, strip windows, coverings, dividing walls and internal or external installations.

SPECIFICATION ITEM

Modular panel for coverings, infills or windows; 435 mm coextruded multiwall polycarbonate, external side with UV protection. 40 mm thick, coplanar, with patented watertight joint. Technical features: Ug transmittance = 1.0 W/m²K, fire reaction B-s1,d0, transparent frost, opaque or coloured finishing.



TECHNICAL DATA

Geometry	9 walls with tunnel structure
Thickness	40 mm
Width	435 mm
Length	Custom
Light transmission	Clear: 48 %
Heat transfer coefficient (Ug)	1.0 W/m ² K
Fire Classification	B-s1,d0
Minimum bending radius	8,000 mm
Sound reduction index	18 dB *evaluated
Thermal linear enlargement	0.065 mm/m °C
Serving temperature	-100 / +120 ° without load
Available colours	Clear frost, Opal, Bronze, Other colours on request
Additional services	Taping

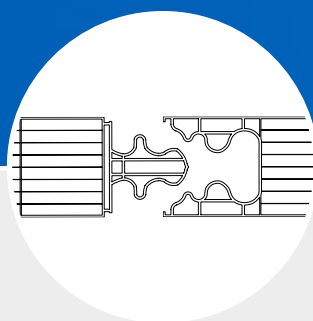
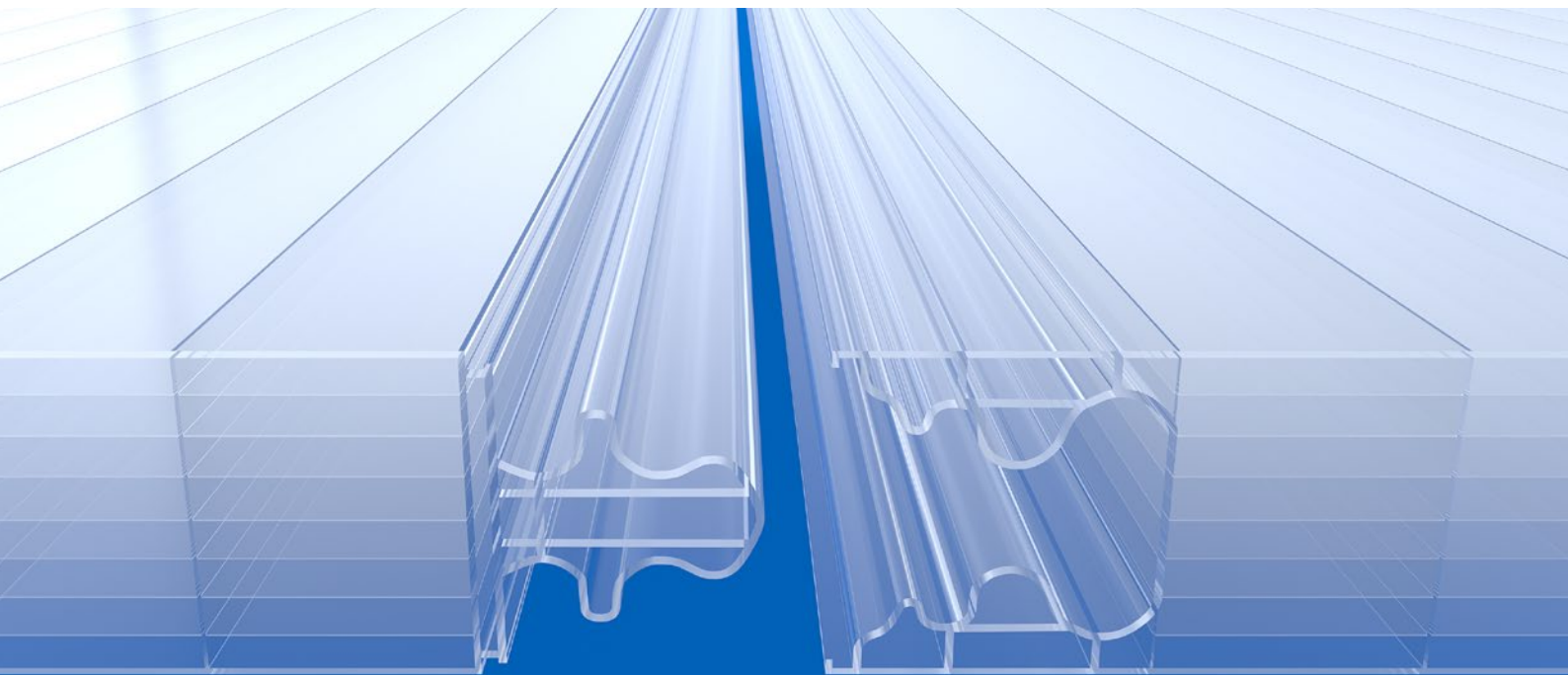

patented watertight coupling

 **MECHANICAL PERFORMANCES**

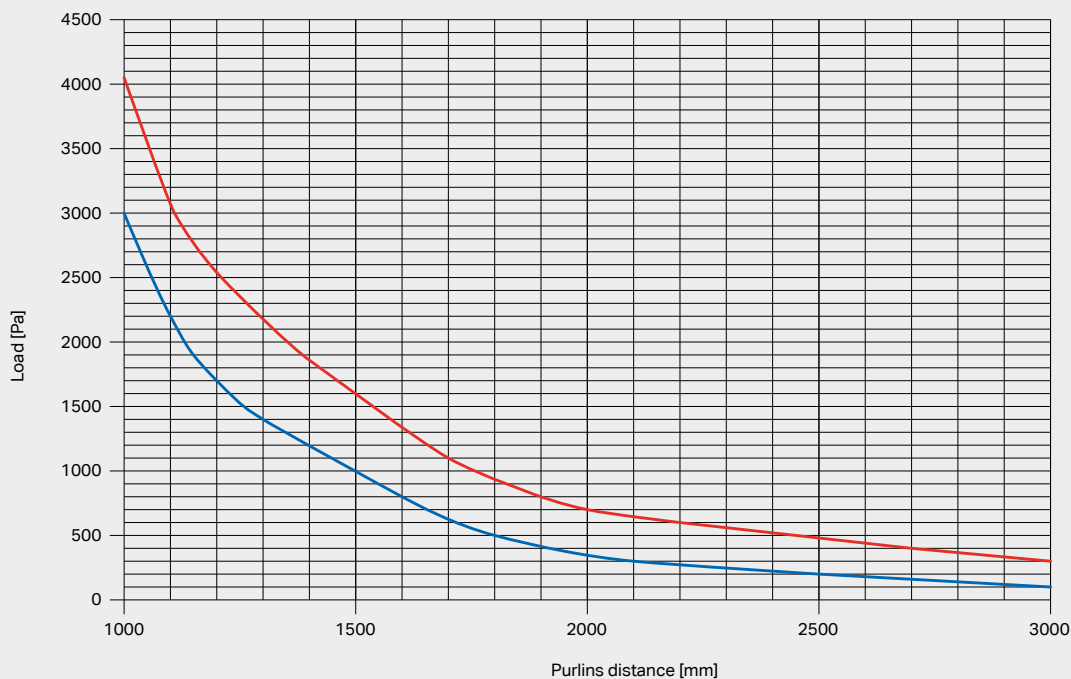

— 40 mm 9P - Single span
— 40 mm 9P - Multispan

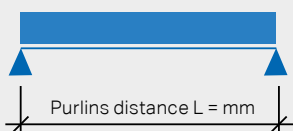

Single span system is generally used for windows and sheds or in the applications where the panels are supported on the edges only.

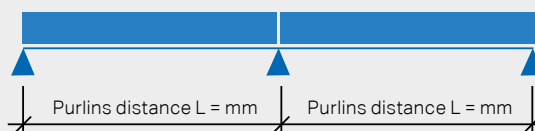

Multi span system is generally used for facades or in the applications where the panels are supported on the edges and along the length with intermediate purlins.

Accessories for Exolon® Panel 40 3P, 40 5PX, 40-9P

System with thermal break

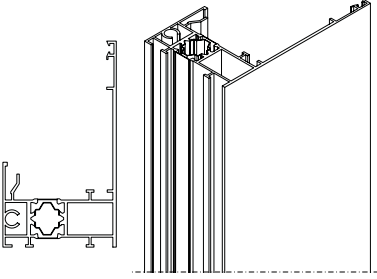
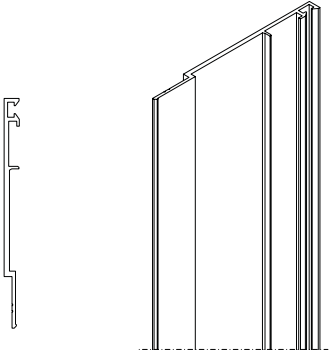
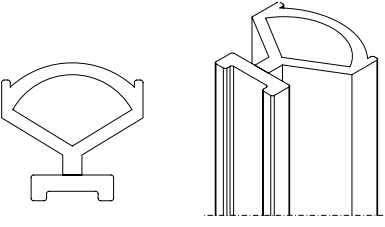
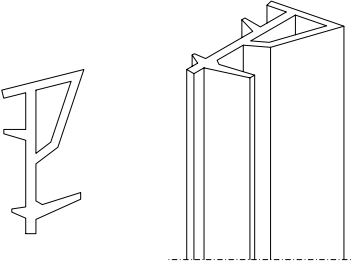
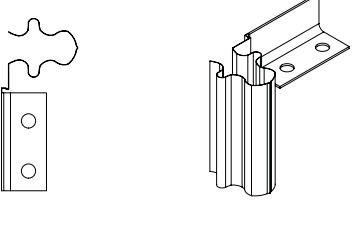
ACCESSORIES	CODE	DESCRIPTION	USE
	PAETBT0612	<ul style="list-style-type: none"> • Anodised aluminium L profile with thermal cut • For 40 mm thickness • 6,500 mm length 	Upper, lower and side profile
	PAETB44975	<ul style="list-style-type: none"> • Anodised aluminium panel fixing element • For 40 mm thickness • 6,500 mm length 	Panel fixing element in combination with PAETBT0612
	GUAPA03	<ul style="list-style-type: none"> • EPDM gasket 	PAETBT0612 upper, lower and side profile gasket; and PAETB44975 upper and side panel fixing element gasket
	GUAPABO	<ul style="list-style-type: none"> • EPDM gasket 	PAETB44975 panel fixing element gasket in the lower section
	G00040	<ul style="list-style-type: none"> • Steel hook 	Steel hook for panel mounting

Accessories for Exolon® Panel 40 3P, 40 5PX, 40-9P

System without thermal break

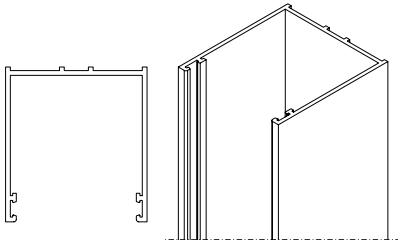
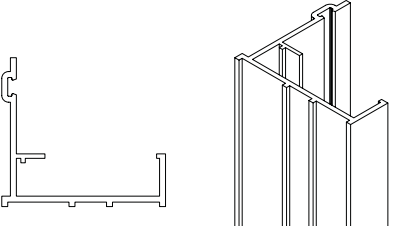
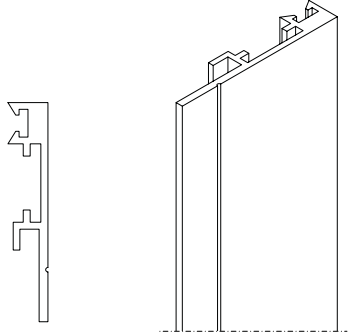
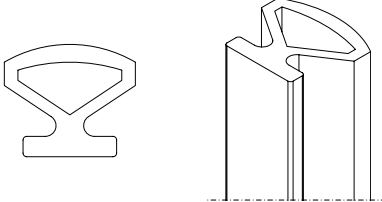
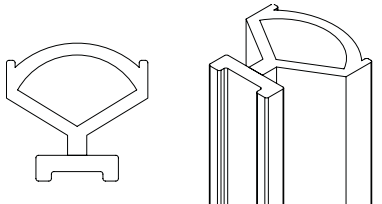
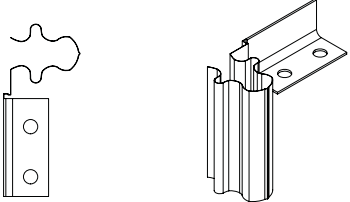
ACCESSORIES	CODE	DESCRIPTION	USE
	PAEF12632B	<ul style="list-style-type: none"> • Anodised aluminium profile (10 micron) • For 40 mm thickness • 6,500 mm length • Weight 1.001 kg/m • Alloy UNI 9006/1 6060 	Upper profile
	PAEF12633B	<ul style="list-style-type: none"> • Anodised aluminium L profile (10 micron) • For 40 mm thickness • 6,500 mm length • Weight 0.618 kg/m • Alloy UNI 9006/1 6060 	Lower and side profile
	PAEF12742A	<ul style="list-style-type: none"> • Anodised aluminium panel fixing element • For 40 mm thickness • 6,500 mm length • Weight 0.264 kg/m • Alloy UNI 9006/1 6060 	Panel fixing element combined with PAEF12632B
	GUAPA01	<ul style="list-style-type: none"> • EPDM gasket 	Gasket for profiles PAEF12632B and PAEF12633B
	GUAPA03	<ul style="list-style-type: none"> • EPDM gasket 	PAEF12742A panel fixing element gasket
	G00040	<ul style="list-style-type: none"> • Steel hook 	Steel hook for panel mounting

Installation

For each installation challenge we have a solution (see further for the details).



Stainless steel fastening hook that seamlessly embraces the panel

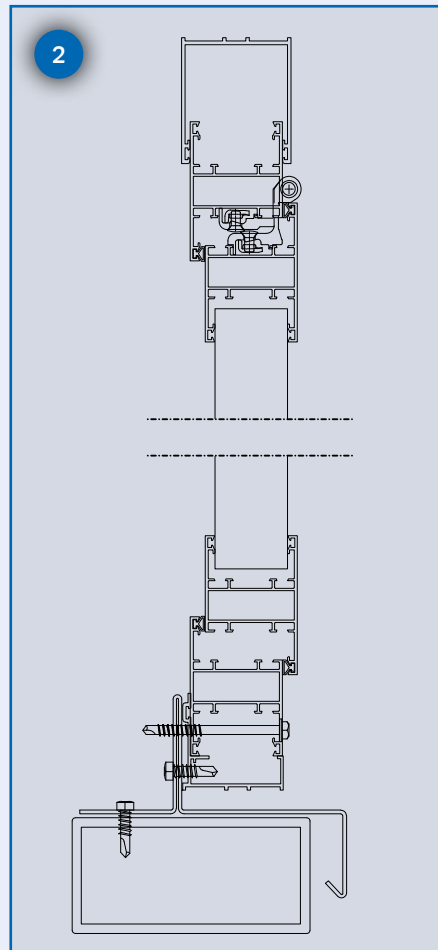

Special top profile allowing dilatation of the panels.
For thermal broken solution in two parts for easy installation



Typical window solution

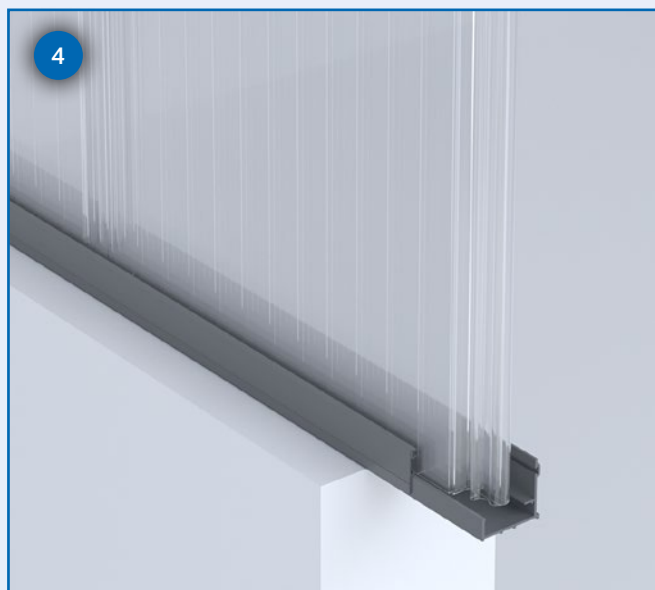

Special bottom profile in two parts for easy installation
of panels and the gaskets



ALMAMARY Aluminium & Skylight Factory

Exolon Polycarbonate Exclusive Distributor
for Industrial Buildings in UAE & GCC

☎ 00971 6 5361040
✉ maen@almamary.ae



Exolon Group S.p.A
Strada Di Vagno 15/A –
05035 Nera Montoro (TR)
Italy

sales@exolongroup.com
www.exolongroup.com

The manner in which you use and the purpose to which you put and utilize our products, technical assistance and information (whether verbal, written or by way of production evaluations), including any suggested formulations and recommendations, are beyond our control. Therefore, it is imperative that you test our products, technical assistance, information and recommendations to determine to your own satisfaction whether our products, technical assistance and information are suitable for your intended uses and applications. This application-specific analysis must at least include testing to determine suitability from a technical as well as health, safety, and environmental standpoint. Such testing has not necessarily been done by Exolon Group. Unless we otherwise agree in writing, all products are sold strictly pursuant to the terms of our standard conditions of sale which are available upon request. All information and technical assistance is given without warranty or guarantee and is subject to change without notice. It is expressly understood and agreed that you assume and hereby expressly release us from all liability, in tort, contract or otherwise, incurred in connection with the use of our products, technical assistance, and information. Any statement or recommendation not contained herein is unauthorized and shall not bind us. Nothing herein shall be construed as a recommendation to use any product in conflict with any claim of any patent relative to any material or its use. No license is implied or in fact granted under the claims of any patent. Exolon® is a registered trademark by Exolon Group.

Edition: 2022 · Order-No.: MF0401 · Printed in Germany